

GP1U50X Series/GP1U51X Series GP1U52X Series/GP1U52Y Series

Light Detecting Unit
for Remote Control
T-41-41

■ Features

1. Various B. P. F. (Band Pass Filter) frequency
2. Two installation type
 - For horizontal PWB.....GP1U50X series, GP1U51X series, GP1U52X series
 - For vertical PWB.....GP1U52Y series

■ Applications

- Light detecting portion of remote control
 1. TVs
 2. VCRs
 3. Audio equipment

■ Model Line-up

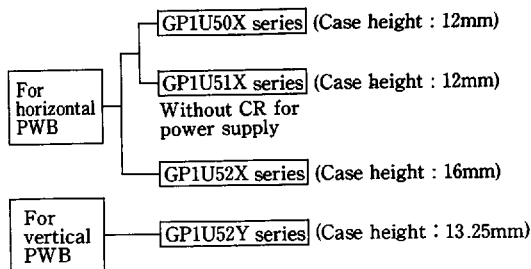

■ Outline Dimensions

(Unit : mm)

GP1U50X/GP1U51X Series

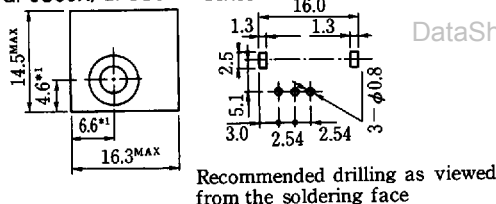

GP1U52X Series

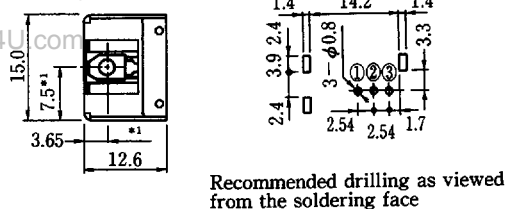

GP1U52Y Series

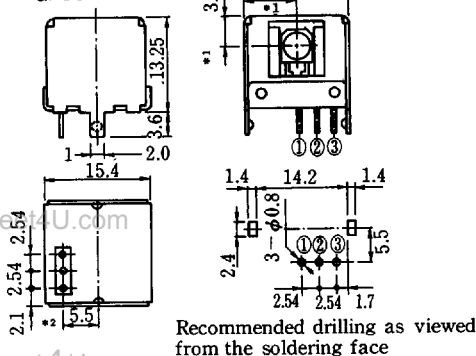

- *1 shows the center of light detector.
- *2 shows the dimension of connector root.

GP1U50X/GP1U51X Series

- ① V_{cc}
- ② V_{out}
- ③ GND

GP1U52X/GP1U52Y Series

- ① V_{out}
- ② V_{cc}
- ③ GND

www.DataSheet4U.com

T-41-4

Absolute Maximum Ratings

(Ta=25°C)

Parameter	Symbol	Ratings	Unit
Supply voltage	V _{cc}	6.3	V
*1 Operating temperature	T _{opr}	-10~+60	°C
Storage temperature	T _{stg}	-20~+70	°C
*2 Soldering temperature	T _{sol}	260	°C

*1 No dew formation

*2 For 5 seconds

Recommended Operating Conditions

Parameter	Symbol	Value	Unit
Supply voltage	V _{cc}	4.7~5.3	V

Electrical Characteristics

(Ta=25°C, V_{cc}=+5V)

Parameter	Symbol	Conditions	MIN.	TYP.	MAX.	Unit	
Dissipation current	I _{cc}	No input light	—	—	5.0	mA	
High level output voltage	V _{OH}	*3	V _{cc} -0.5	—	—	V	
Low level output voltage	V _{OL}		—	—	0.45	V	
High level pulse width	T ₁		GP1U50X/GP1U51X series	440	—	770	μs
			GP1U52X/GP1U52Y series	400	—	800	
Low level pulse width	T ₂	GP1U50X/GP1U51X series	440	—	770	μs	
		GP1U52X/GP1U52Y series	400	—	800		
B. P. F. center frequency	f _o		—	※※40	—	kHz	

*3 The burst wave as shown in the following figure shall be transmitted by the transmitter shown in Fig. 1.

※※ Diversified models with a different B. P. F. frequency, as shown in a separate table, are also available.

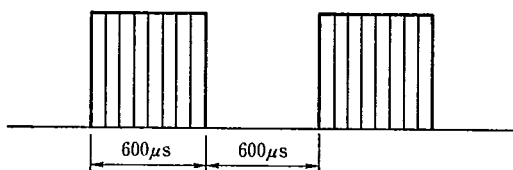
The value of f_o is shown in a separate table.

Duty 50%

Internal Block Diagram

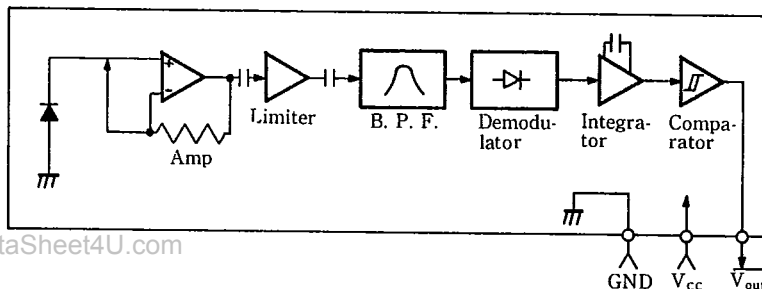

Using the transmitter shown in Fig. 1, the output signal of the light detecting unit is good enough to meet the following items in the standard optical system in Fig. 2.

(1) Linear reception distance characteristics

When $L=0.2\sim 8\text{m}$, $E_e < 10 \text{ lx}$ and $\phi = 0^\circ$ in Fig. 2, the output signal shall meet the electrical characteristics in the attached list.

(2) Sensitivity angle reception distance characteristics

When $L=0.2\sim 6\text{m}$, $E_e < 10 \text{ lx}$ and $\phi \leq 30^\circ$ in Fig. 2, the output signal shall meet the electrical characteristics in the attached list.

(3) Anti outer peripheral light reception distance characteristics

When $L=0.2\sim 4\text{m}$, $E_e \leq 300 \text{ lx}$ and $\phi = 0^\circ$ in Fig. 2, the output signal shall meet the electrical characteristics in the attached list.

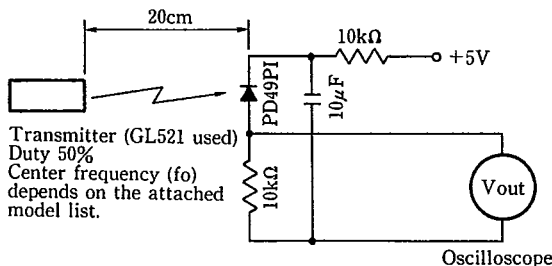

In the above figure, the transmitter should be set so that the output V_{out} can be 40mV_{pp} . However, the PD49PI to be used here should be of the short-circuit current $I_{sc} = 2.6\mu\text{A}$ at $E_v = 100 \text{ lx}$.

(E_v is an illuminance by CIE standard light source A (tungsten lamp).)

Fig. 1 Transmitter

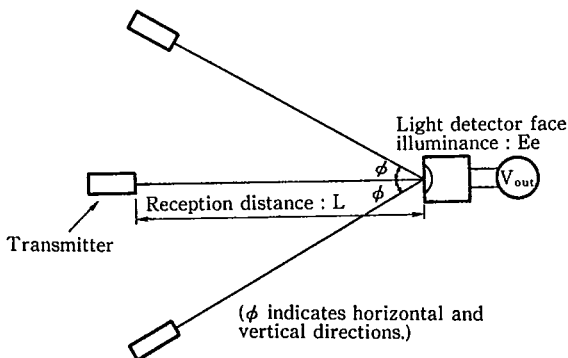

Fig. 2 Standard optical system

T-41-41

■ Model Line-up

Model No.	B. P. F. frequency	Unit
GP1U50X/GP1U51X/GP1U52X/GP1U52Y	40	kHz
GP1U501X/GP1U511X/GP1U521X/GP1U521Y	38	
GP1U502X/GP1U512X/GP1U522X/GP1U522Y	36.7	
GP1U503X/GP1U513X/GP1U523X/GP1U523Y	32.75	
GP1U505X/GP1U515X/GP1U525X/GP1U525Y	41.7	
GP1U506X/GP1U516X/GP1U526X/GP1U526Y	48	
GP1U507X/GP1U517X/GP1U527X/GP1U527Y	56.8	
GP1U508X/GP1U518X/GP1U528X/GP1U528Y	39	
GP1U509X/GP1U519X/GP1U529X/GP1U529Y	35	

■ Precautions for Use

- (1) Use the light emitting unit (remote control transmitter), in consideration of performance, characteristics and operating condition of light emitting device and the characteristics of the light detecting unit.
- (2) Pay attention to a malfunction of the light detecting unit when the surface is stained with dust and refuse.
Care must be taken not to touch the light detector surface.
If it should be dirty, wipe off with soft cloth so as to prevent scratch. In case some solvents are required, use methyl alcohol, ethyl alcohol or isopropyl alcohol. Also, protect the light detecting unit against flux and others.
- (3) The shield case shall be grounded on PWB pattern.
- (4) Do not apply unnecessary force to the terminals and case from outside.
- (5) Do not push the light detector surface (photodiode) from outside.
- (6) To avoid the electrostatic breakdown of IC, handle the unit under the condition of grounding with human body, soldering iron, etc.
- (7) In case of adopting the infrared light detecting unit for the wireless remote control, use it in accordance with the transmission scheme and the signal format recommended in "Countermeasures for malfunction prevention of home appliances with infrared remote control" issued from Japan Association of Electrical Home Appliances (AEHA) in July 1987.